



# Aeon Series

## EDGE FREE® Fixed Frame Projection Screen









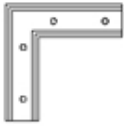

### User's Guide

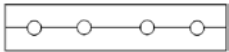
Applies to all available screen materials:  CineGrey 3D® EDGE FREE® and CineWhite® EDGE FREE®

**Product Description:** The Aeon Series is a fixed frame projection screen that uses Elite's EDGE FREE® technology. The EDGE FREE® design resembles a giant size flat panel TV display. The Aeon includes an ultra-thin trim as an installation option to further enhance the frame appearance and absorb projector overshoot. An optional LED backlighting kit is available for added visual appearance.

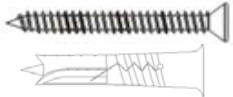
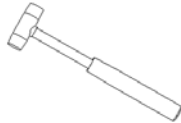
### Hardware and Parts List

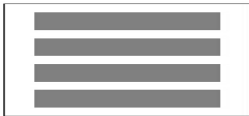
Please make sure all parts listed below are included before installation.

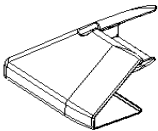
<p><b>A. Elbow joint x4 pcs</b></p>	<p><b>B. Top/Bottom horizontal frame x4 pcs</b></p>	<p><b>C. Left/Right vertical frame x2 pcs</b></p>	<p><b>D. Center joints x2 pcs</b></p>
			
<p><b>E. Center Support bar x1-3 pcs</b></p>	<p><b>F. Wall brackets x2-3 pcs</b></p>	<p><b>G. M5x15 screw x24 pcs</b></p>	<p><b>H. M5x50 screws and anchor x6 pcs</b></p>
 <p>(135"-150" x2 pcs; 180"-200" x3 pcs)</p>			
<p><b>I. Rubber hammer x1 pc</b></p>	<p><b>J. Screwdriver x1 pc</b></p>	<p><b>K. Black Tape x1 bag</b></p>	<p><b>L. Bezel trim x6 pcs</b></p>
			
<p><b>M. Corner Support Bar (180"-200") x4 pcs</b></p>	<p><b>N. Corner sleeve x4 pcs</b></p>		
			

## Frame Assembly

1. Insert the center joint into one of the  $\frac{1}{2}$  *horizontal frames (B)* and fasten it with the two *M5x15 screws (G)*.
2. Insert the other  $\frac{1}{2}$  horizontal frame piece to the center joint and fasten also using two *M5x15 screws*.
3. Repeat steps 1 and 2 for assembling the second horizontal frame.

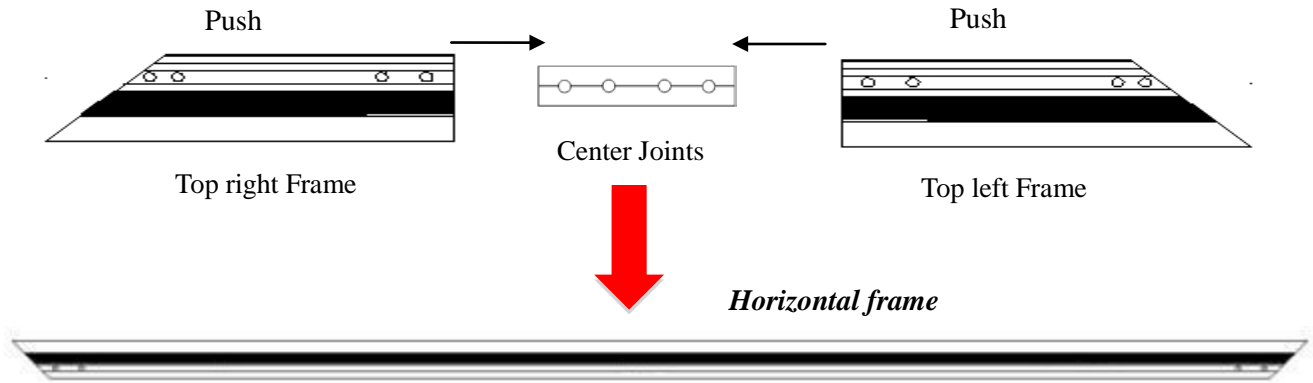

4. Insert the *elbow joint (A)* into each end of the *horizontal frames (B)* as shown below.

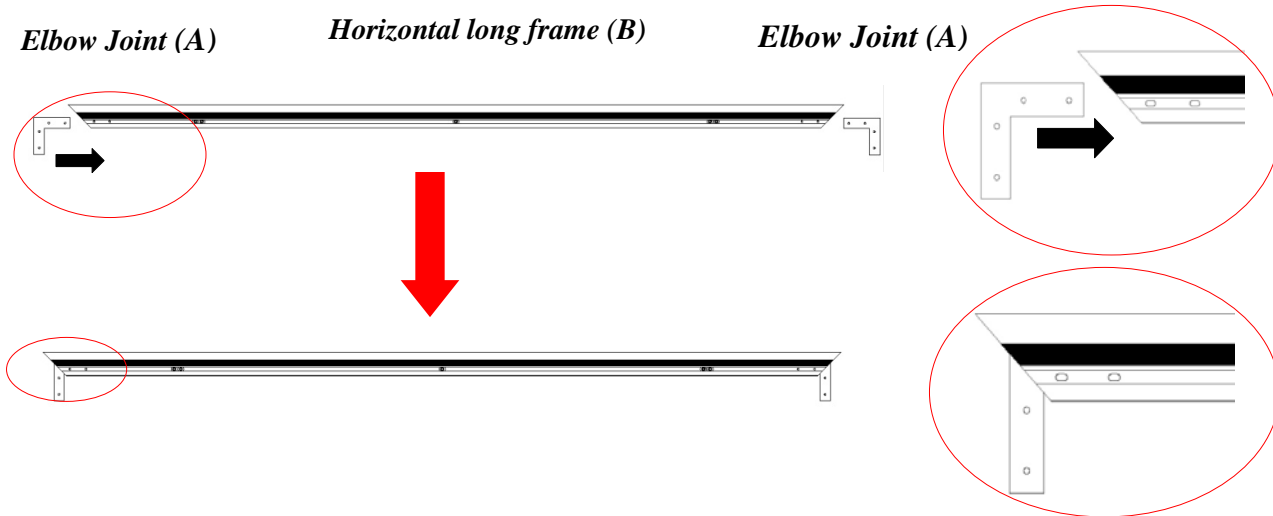

5. Insert the two *vertical short frames (C)* into the *elbow joint (A)*.

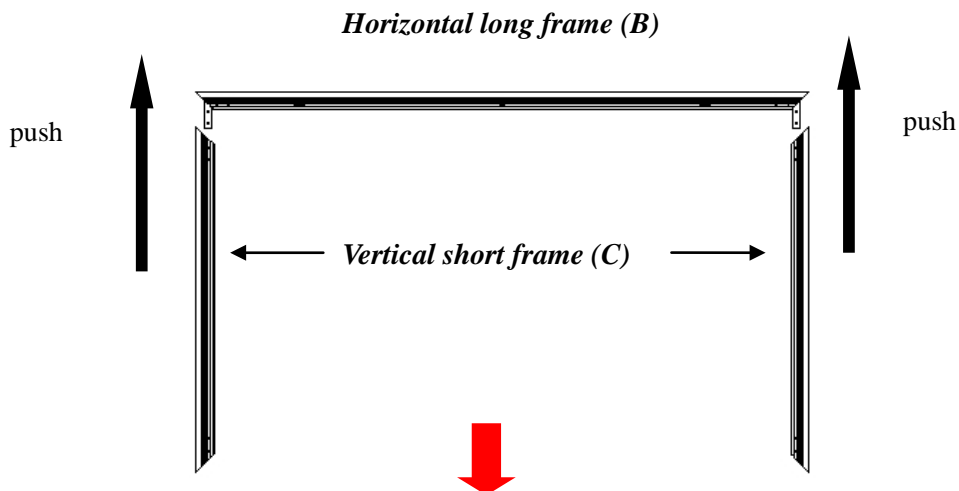



6. Join the remaining *horizontal long frame (B)* with the frame built in the previous steps as shown below.

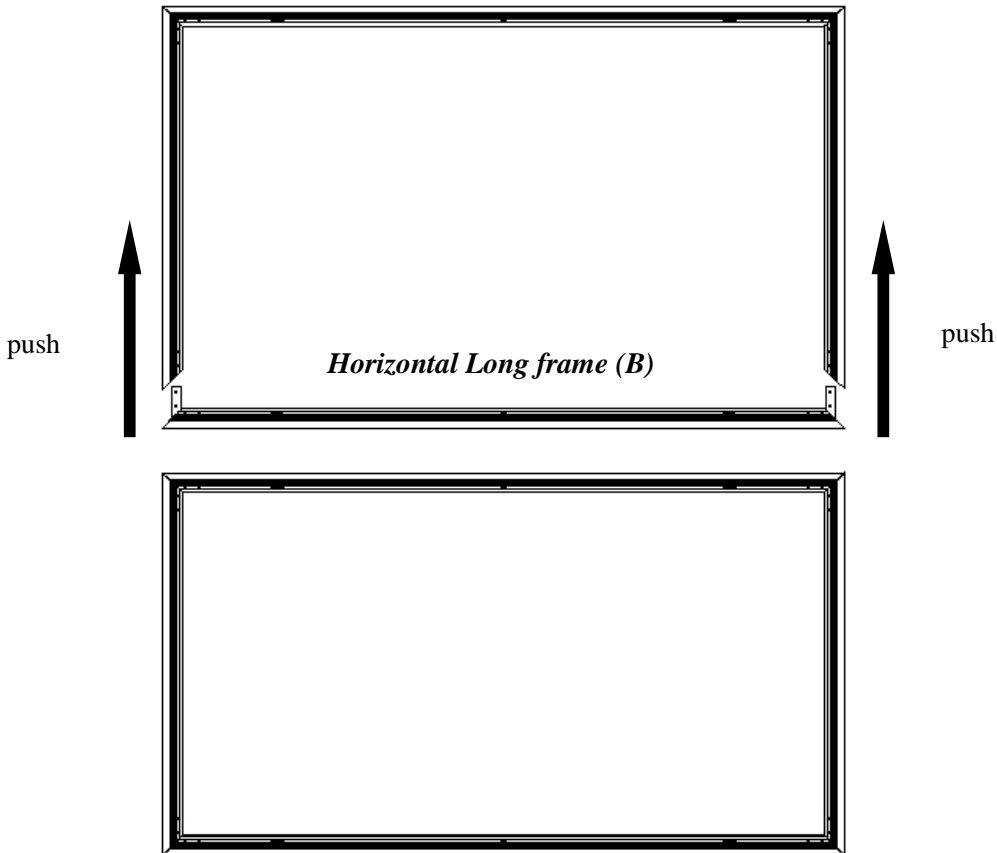

7. Make sure all four corners are properly in place to form a perfect square. Then fasten the four angles with the *M5x15 Screws (G)*.

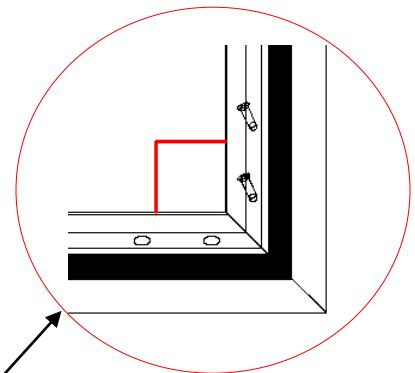
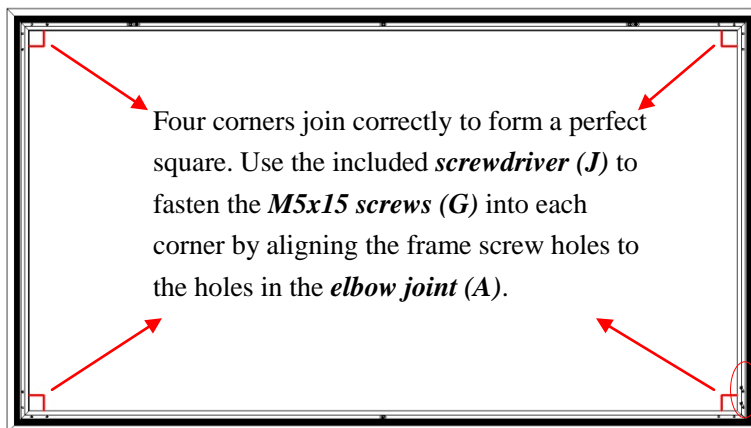

## Screen Material Installation

1. Lay the *screen material* completely flat with the front facing down on a clean surface in a horizontal position. The back side of the screen material should be placed upwards.

*Note: The back side of the material has the velcro borders all around the edges.*

2. Carefully and gently place the assembled frame on top the screen material as shown below. Make sure to not allow the angle edge of the frame to come in direct contact with the screen material to avoid puncturing it.

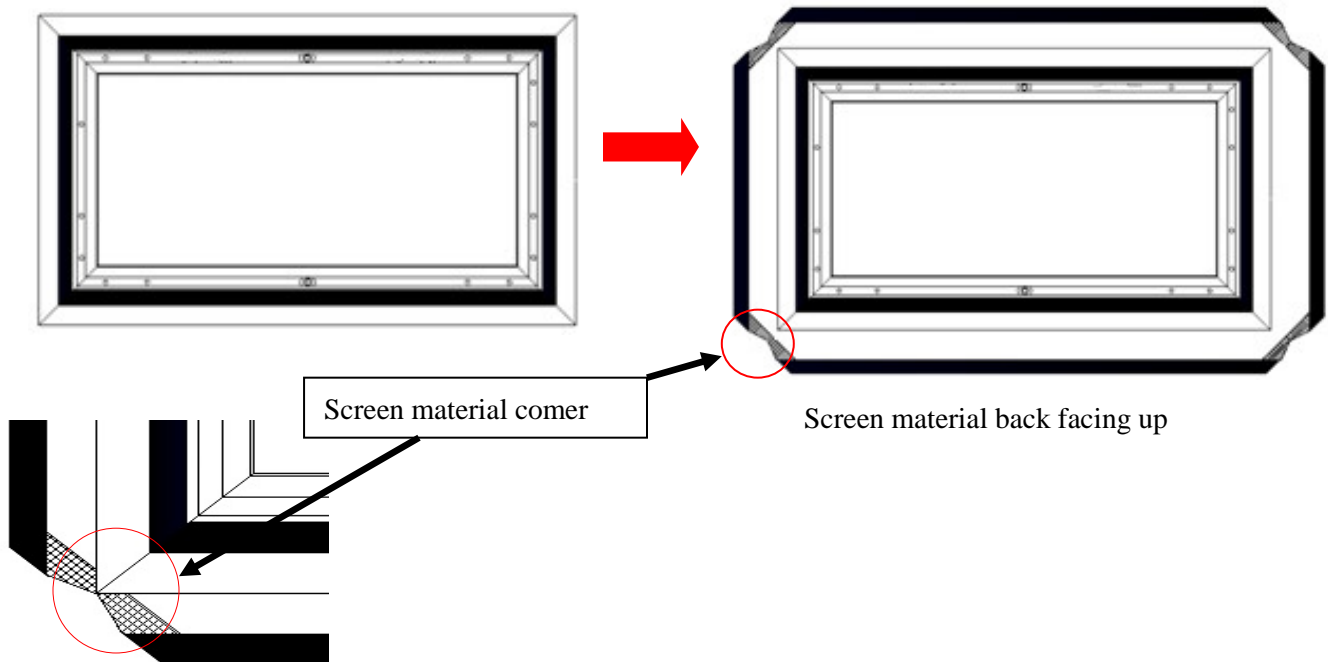

3. After all of the corners of the frame have been properly aligned, attach the material to the frame in the following order A→B→C→D (see instructions below for details).

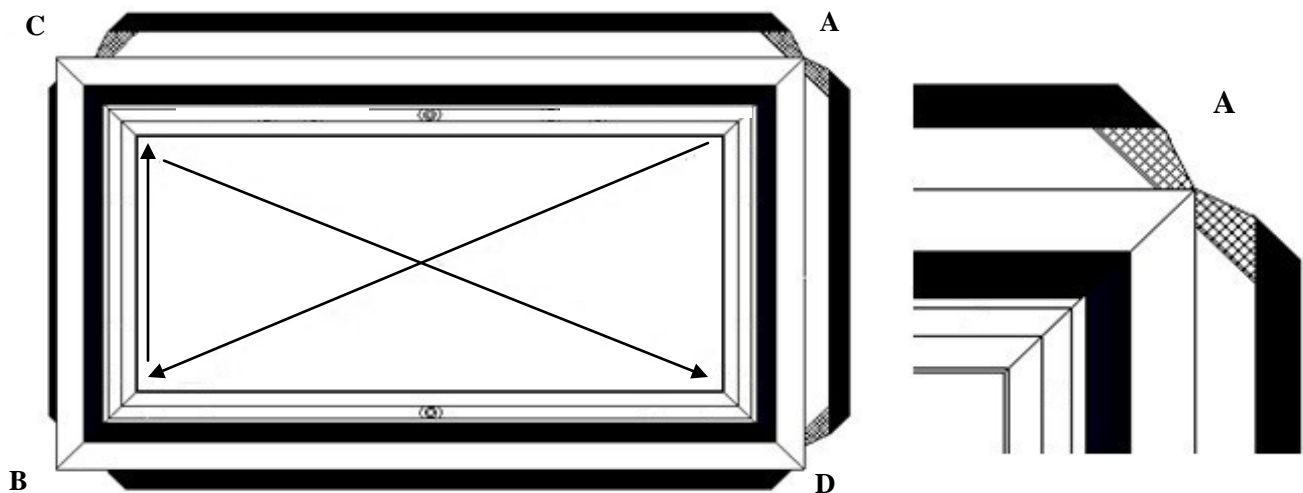

**Attach the screen material to the corners as shown below.**

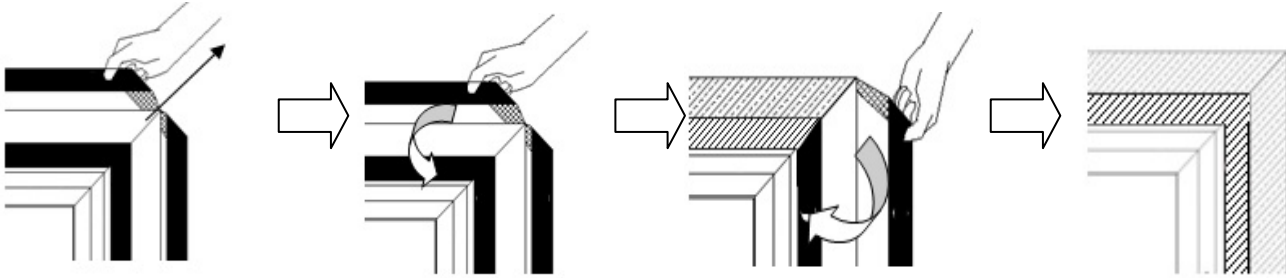

1) Stretch the screen material in the direction of the arrowhead.

2) Fold over and attach material to the velcro strip of the frame.

3) Fold over second side and attach to frame

4) Repeat until all four sides are done in the order A, B, C, D

4. After all four corners have been attached; please check whether the frame corners are wrapped by the screen material. If not, please loosen the velcro connection and repeat the above steps so the frame is not exposed.

**Note:**  
Represents the screen material

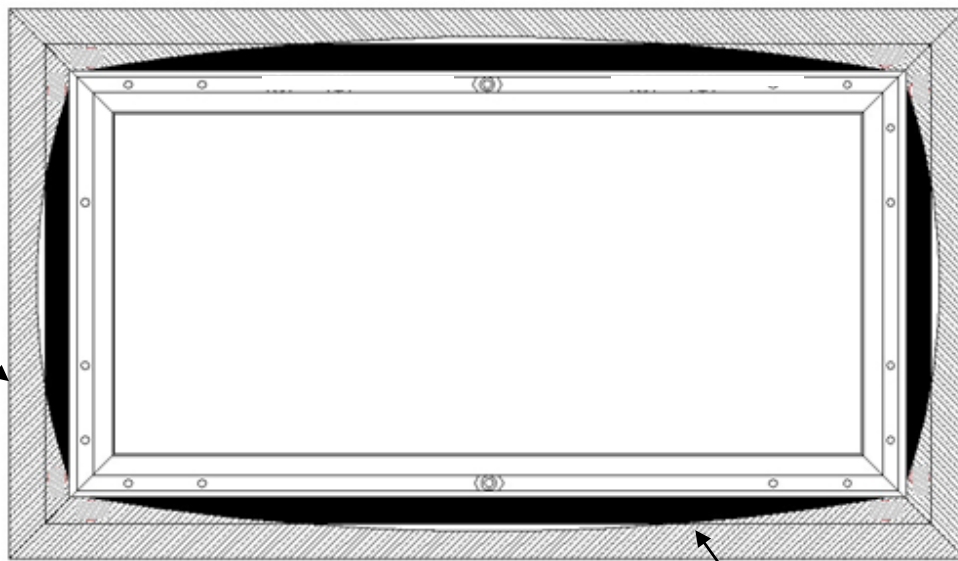

**Note:** The black shaded part represents the velcro on the frame. That Velcro end will ultimately attach with the other velcro end on the screen material.

5. Proceed to attach the rest of the material to the frame as described in the illustrations below.

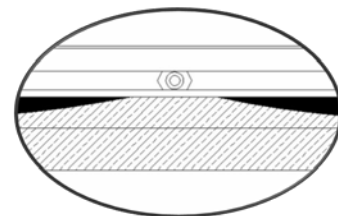
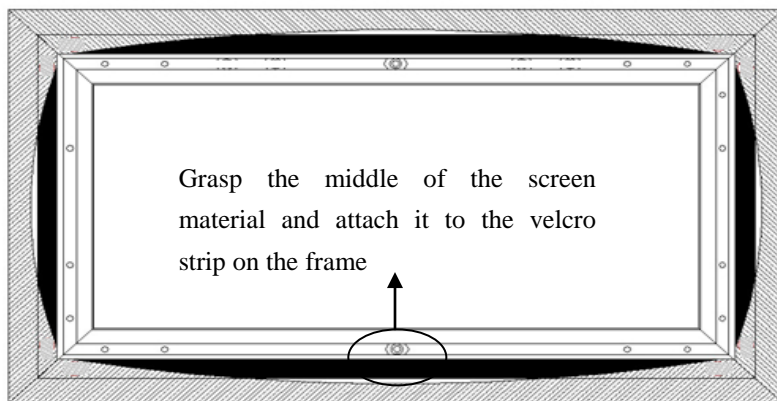

Lay the Velcro end on the screen material over the Velcro end of the frame and keep it within the edge.

Proceed in the following sequence below ①→②

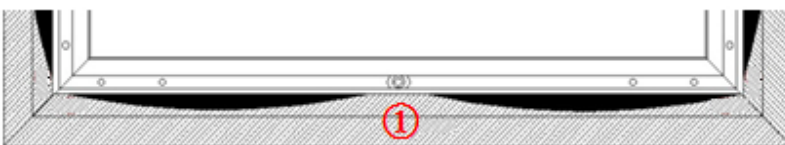

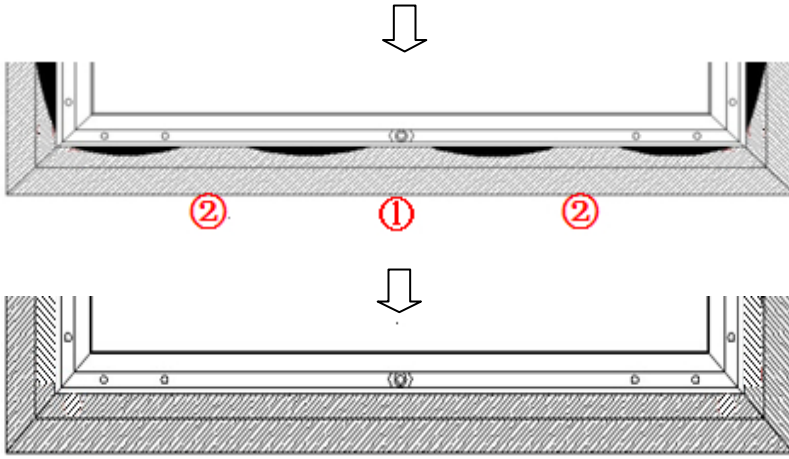

The key is to attach within the middle sections of 1 and 2. Then continue attaching the remaining unattached areas.

Repeat the same steps on remaining three sides in the sequence A, B, C, and then D as show below.

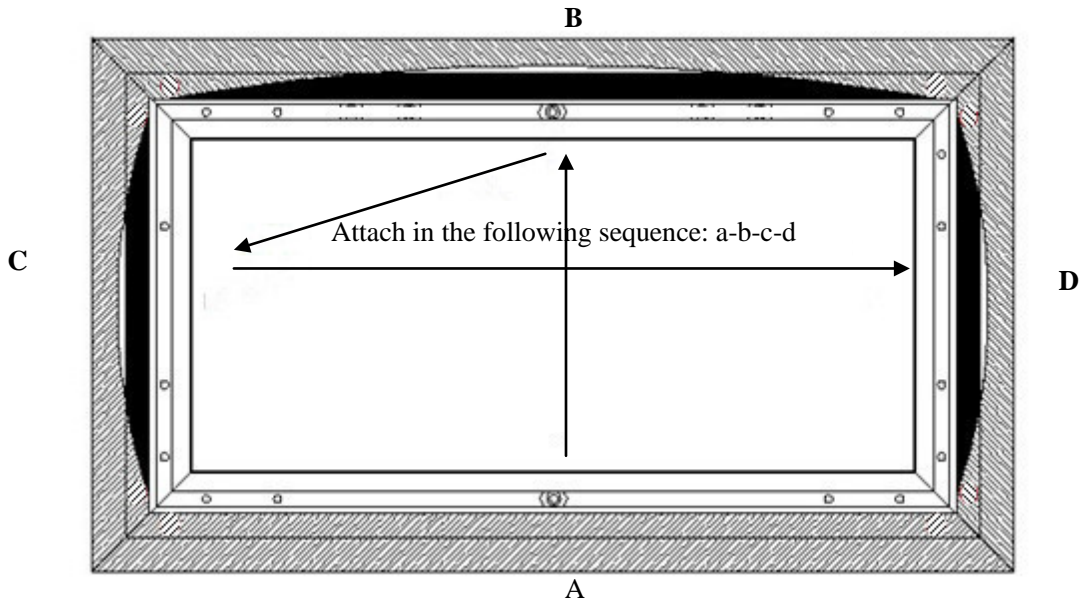

6. If the material is too loose or tight after adjusting all four corner sides, then you will need to reattach the material. *Please follow the steps below to properly remove the screen material from the frame. This procedure will ensure prolonging the life of the screen material.*

### **Screen Material Removal**

1. Detach the velcro from the frame.
2. Gently pull back the material to release it from the velcro connections on the corners

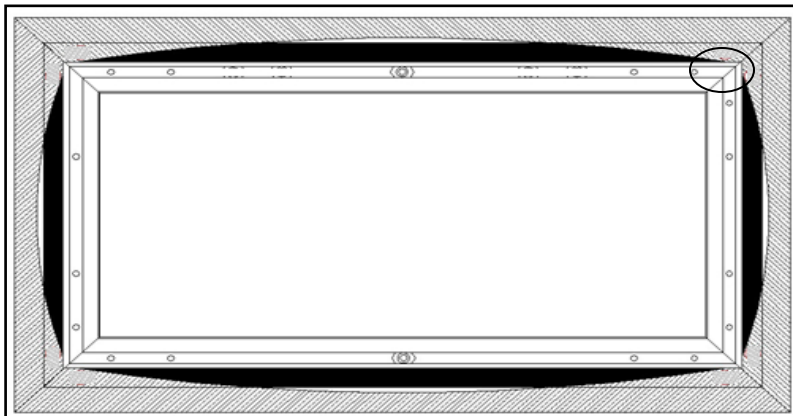

Pull back the screen material from the velcro connection along the edges of the frame to detach it.

### Support bar installation (for models under 135")

1. Position the *center support bar (E)* in the middle of the frame and align the hole on each end of the support bar with the *M6 hex screws* on the top and bottom frames. Then fasten with the *M6x12 screws*.

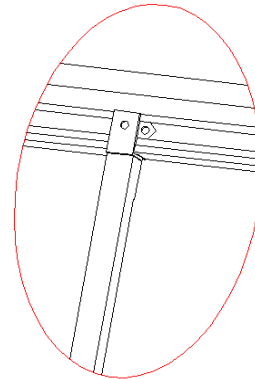
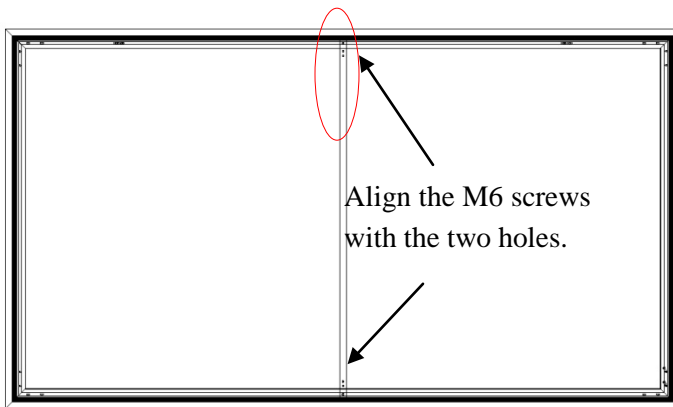
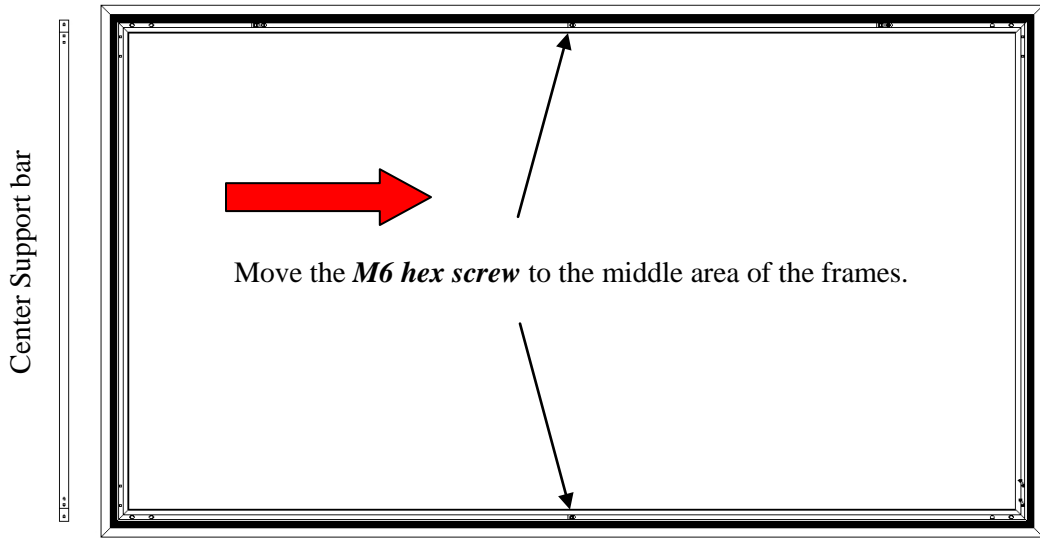

### Support bar installation (for models 135"- 150")

1. Position the *center support bar (E)* and *M6 hex screws* in the areas of the frame shown in fig 1. (Each about one thirds the way in from the end of the frame.) Align the hole on each end of the support bar with the *M6 hex screws* located at the top and bottom frame sections. Then fasten with the *M6x12 screws*.

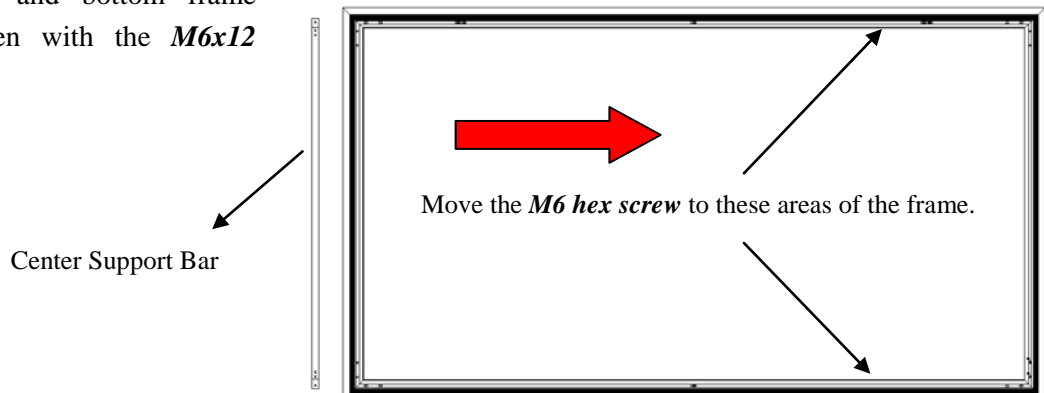

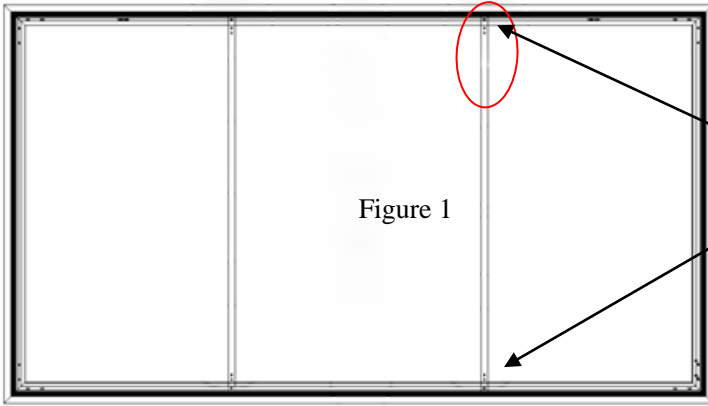

Align the M6 Screws with the two holes located on the Center Support Bar.

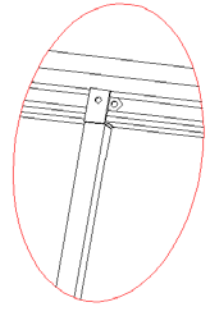

**Support bar installation (for models 180''- 200'')**

2. Position the *center support bar (E)* and *M6 hex screws* in the areas of the frame shown in fig 1. Align the hole on each end of the support bar with the *M6 hex screws* located at the top and bottom frame sections. Then fasten with the *M6x12 screws*.

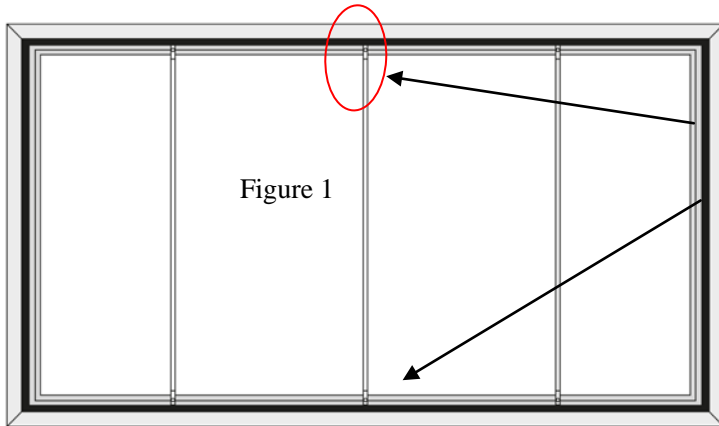
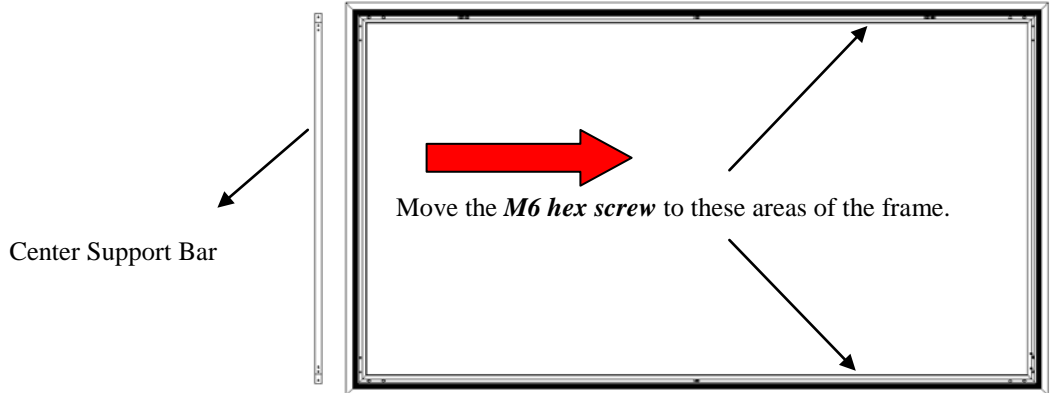

Align the M6 Screws with the two holes located on the Center Support Bar.

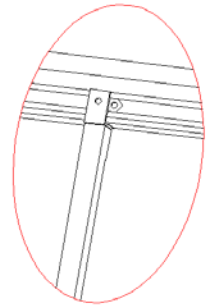

1. Position the *Corner support bars (M)* and *M6 Hex screws* in the areas of the frame as shown below in fig 2.
2. Align the holes on each end of the corner support bars with the M6 hex screws located on the vertical and horizontal frame sections. Then fasten with the *M6x12 screws*.



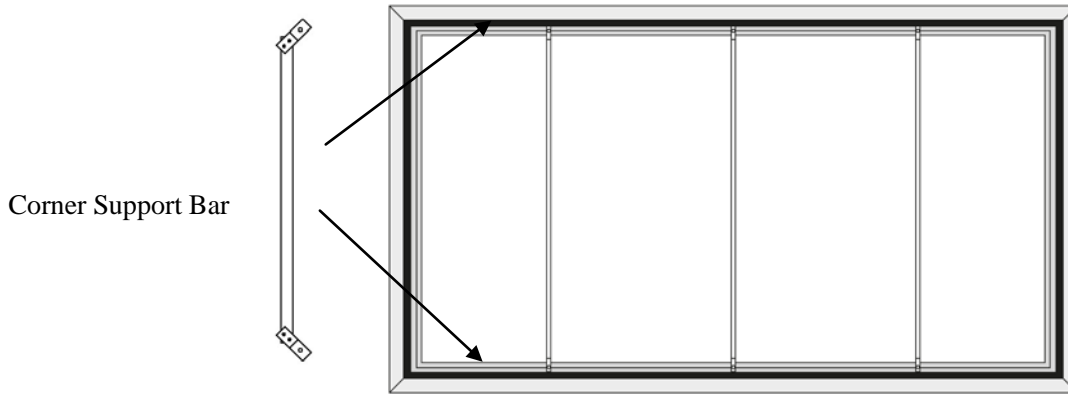
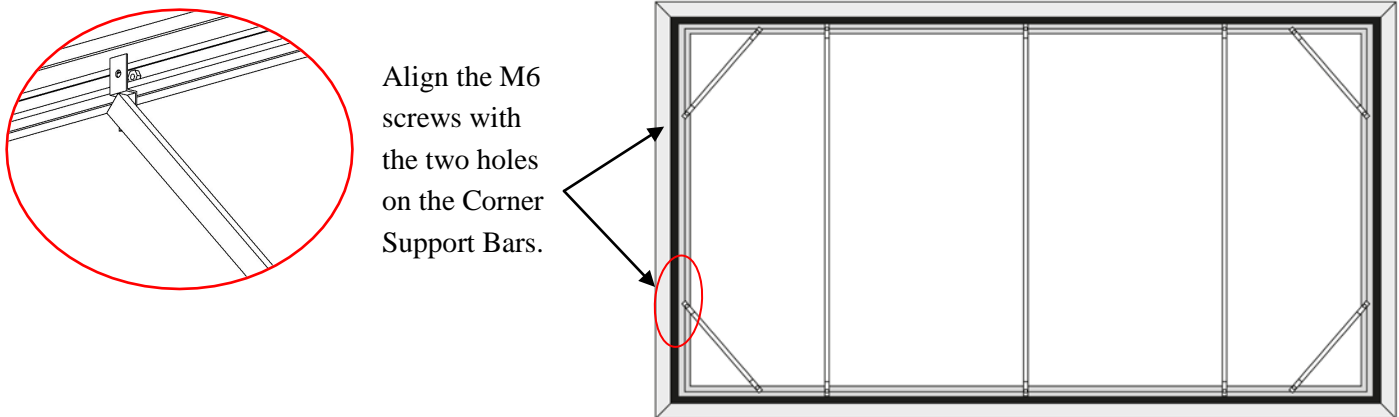

Figure 2



**Notice to Installer:**

Please use the following installation instructions to obtain superior optical performance from the CineGrey 3D® Angular Reflective ALR (Ambient Light Rejecting) Screen.

Make sure to follow these instructions in order for the CineGrey 3D® to perform correctly.

- Angular-Reflective material is not compatible with ultra/short-throw projectors
- Minimum lens throw ratio 1.5x image width
- Ambient light must not come from the same direction as the projector

*Since angular-reflective means that the projected image will reflect at the mirror-opposite angle, it is important to position the projector so that the viewer will get the best possible image.*

**Step 1:** Establish the general “eye level” of the viewers

**Step 2:** Set the appropriate projection level

**Step 3:** Adjust the screen height level and projection angle  
**Input Angle (A) = Output Angle (B) aligns with the viewer’s angle**

## Correct Installation Examples

**Projector Ceiling Installation:** Make sure the projector (*light in*) is angled (A) to reflect (B) at the mirror-opposite angle (*light out*) to align with the viewer's eye level.

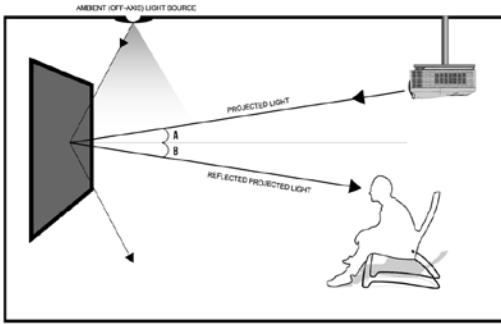

PROJECTOR CEILING INSTALLATION

**Projector Table Top:** Make sure the projector (*light in*) is angled (A) to reflect (B) at the mirror-opposite angle (*light out*) to align with the viewer's eye level.

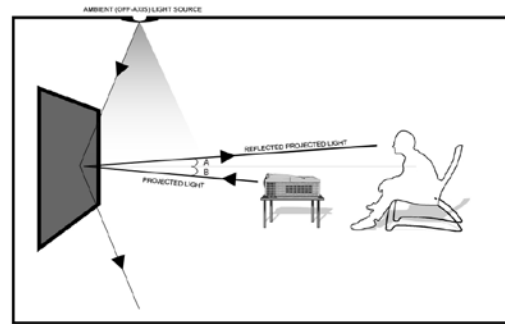

PROJECTOR TABLE TOP INSTALLATION

## Incorrect Installation Examples

**Ceiling Mounted Short-throw Projector**

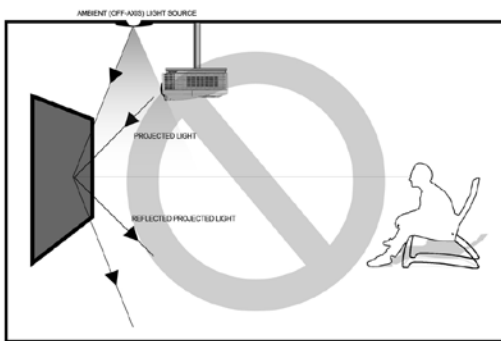

CLOSE UP CEILING PROJECTOR ILLUSTRATION (NOT COMPATIBLE)

**Tabletop Ultra-Short throw Projector**

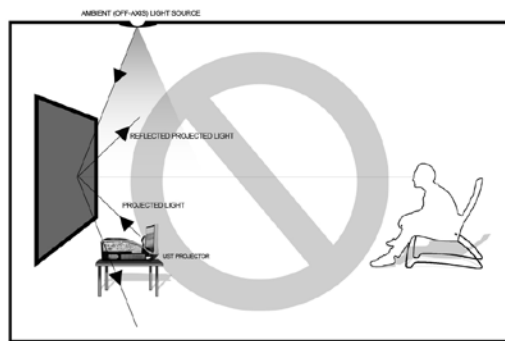

ULTRA SHORT THROW PROJECTOR ILLUSTRATION (NOT COMPATIBLE)

**Note:** Improper installation will result in light loss and produce a dark image. This is due to the projector's light reflecting in the wrong direction.

*Images are not up to scale and are for illustration purposes only.*

## Edge trim Installation

Included is an ultra-thin black edge trim that provides an elegant bezel finish

Edge trim x 6 PCS

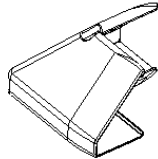

Plastic corner sleeve x4pcs



Black tape x1pcs

1. Place the assembled frame on a flat and clean surface. The projection screen surface should be facing up.
  - a. As an option, Black Tape is supplied to cover any possible gaps between the pieces of the bezel trim. Align the tape with the edge of the screen, as shown in Figure 1. Once properly aligned, apply the black tape to the center of the top and bottom of the screen material.

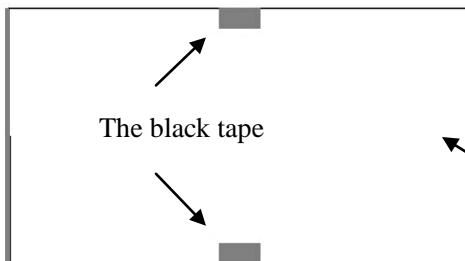
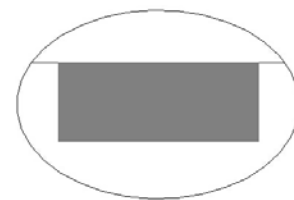

Figure 1

Screen Material



The black tape

2. Without removing the adhesive tape, place all the trim pieces along the edge of screen material. Adjust the trim so that the top and bottom trim pieces are touching and show no gaps in the center. (Note: The Elite logo should be positioned on the bottom right). Refer to Figure 2 below for a visual reference.

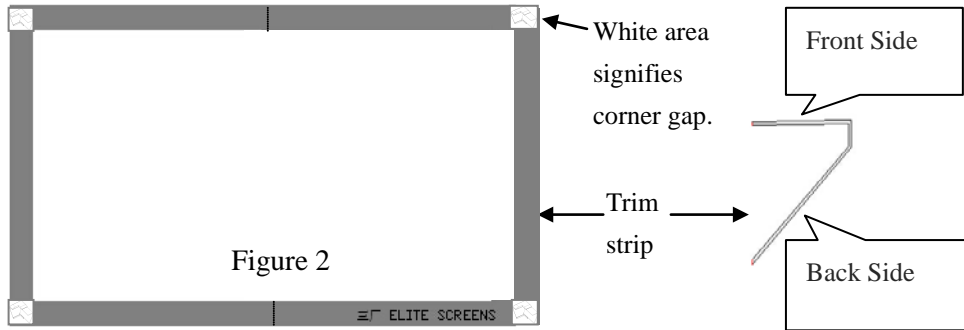

**TIP:**  
Align the trim starting from the center to reduce gapping. Any gaps left at the corners will be covered by the corner sleeves.

**NOTE:** Make sure the bottom edge trim with the Elite Screens logo is installed on the correct side. The back of the material should be labeled with a DOWN sticker to indicate the material is facing in the down position. The Elite Screens logo should be installed on the DOWN side

3. After properly aligning all trim pieces, carefully remove trim piece A (see Figure 3 below). Remove the inside backing of the tape and place the trim piece in its original position on the frame. Repeat this step for the remaining trim pieces in the following order: B-C-D-E-F.

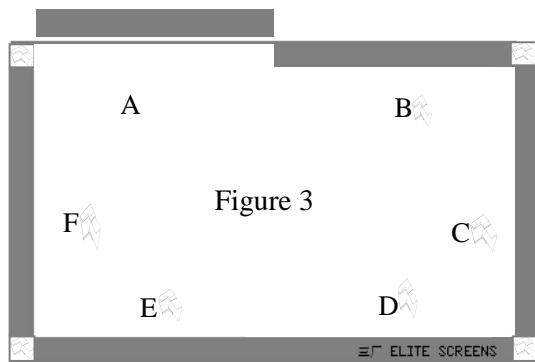

The front side of the frame with trim pieces attached.



4. After the bezel trim has been installed, place a *corner sleeve (N)* on all four corners. Begin by aligning and adjusting the corner sleeve through the front of the screen. Make sure the corner sleeve completely wraps the edge of the bezel trim. This should cover any corner gaps.

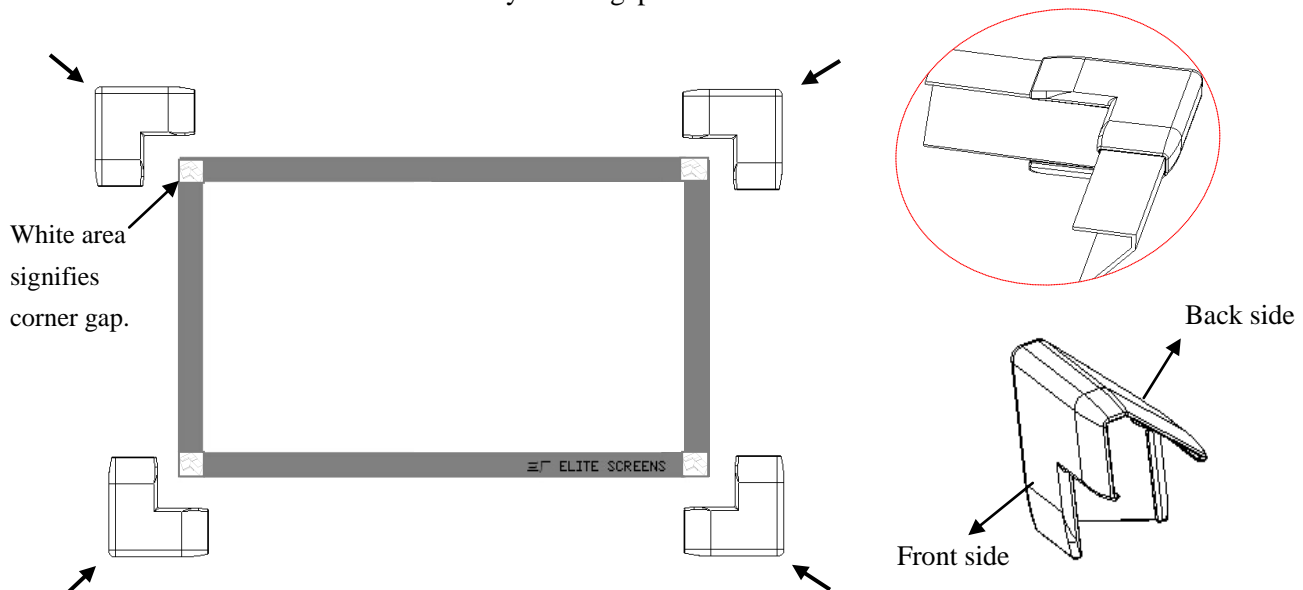

Once all corner sleeves have been snapped into each corner of the frame, it is ready to be installed.

### Diagonal Size Note:

The Diagonal Size of the 100" & 120" models before and after installing the edge trim strip.

101" comparison

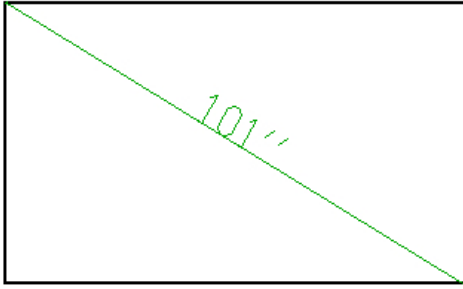

Before installing the trim strip

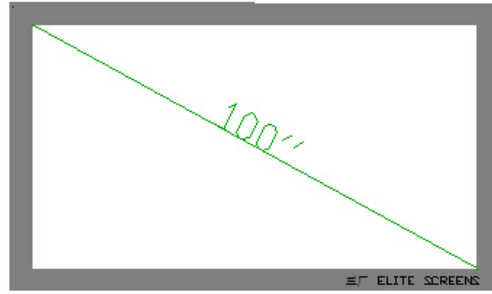

After installing the trim strip

120" comparison



Before installing the trim strip

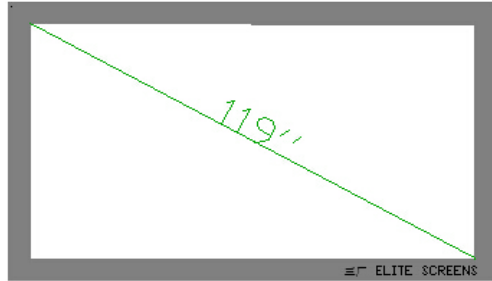

After installing the trim strip

### Installation

Locate your desired installation location with a stud finder (recommended) and mark the drill-hole area of where the screen is to be installed.

1. Drill a hole with the proper bit size according to the wood screws included.
2. Line up the wall brackets with the drilled holes on the installation location and screw them in using a Phillips screwdriver.
3. Position the frame screen onto the **wall brackets (F)** as shown in **below**.
4. The design of the wall brackets allows the frame to slide over them through its sides. This is an important feature of the installation design as it allows your screen to be properly centered.

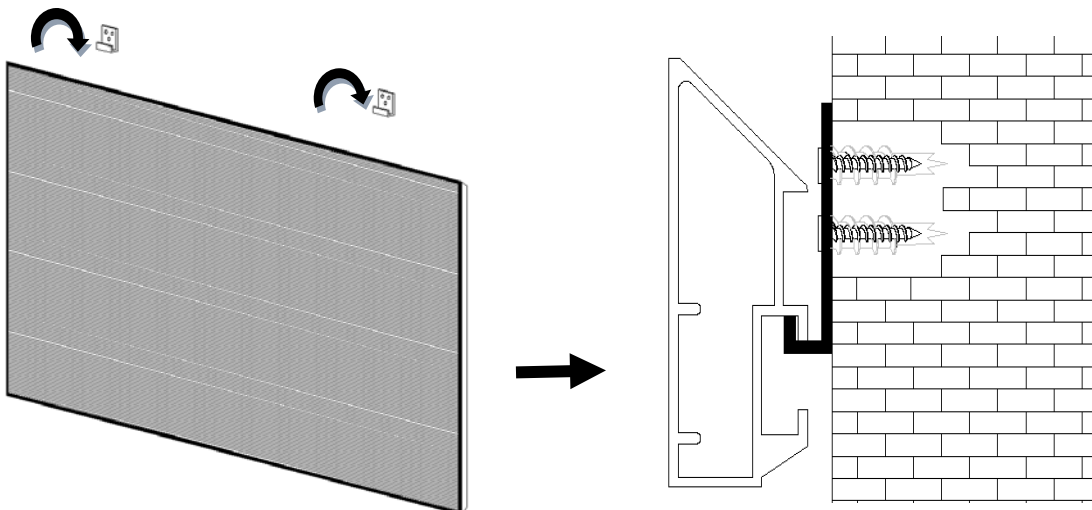

**For a local Elite Screens contact or Technical Support, please visit**

[www.elitescreens.com](http://www.elitescreens.com)