

MODEL L-77ix DIAGRAM PRIMARY ENCLOSURE DIMENSIONS

SPECIFICATIONS

MAX WEIGHT CAPACITY : 150 lbs [68 kg]
 COMBINED WEIGHT OF THE TV, ALL ACCESSORIES, & CEILING COVER
 MAX TRAVEL [EXTENSION] : 52 in [132.1 cm]
 LIFT SYSTEM HEIGHT : 52.25 in [132.7 cm] TO 57.75 in [146.7 cm]
 MAX TV HEIGHT : 45 in [114.3 cm]
 MOTORIZED SWIVEL RANGE : +/- 180°

QUICK REFERENCE DIMENSION GUIDE (USE WHICHEVER IS GREATER)

TV DIMENSIONS : W _____, H _____, D _____

MIN. INTERIOR ENCLOSURE WIDTH : W+2 in [5.1 cm] = _____ OR 35 in [88.9 cm]
 MIN. CEILING COVER CUTOUT WIDTH : W+2 in [5.1 cm] = _____ OR 35 in [88.9 cm]

MIN. INTERIOR ENCLOSURE HEIGHT : SEE CHART ON PAGE 3

MIN. INTERIOR ENCLOSURE DEPTH : D+9.75 in [24.8 cm] = _____
 MIN. CEILING COVER CUTOUT DEPTH : D+9.75 in [24.8 cm] = _____

MIN. INTERIOR ENCLOSURE WIDTH = TV WIDTH + 2 in [5.1 cm] OR 35 in [88.9 cm]
 WHICHEVER IS GREATER

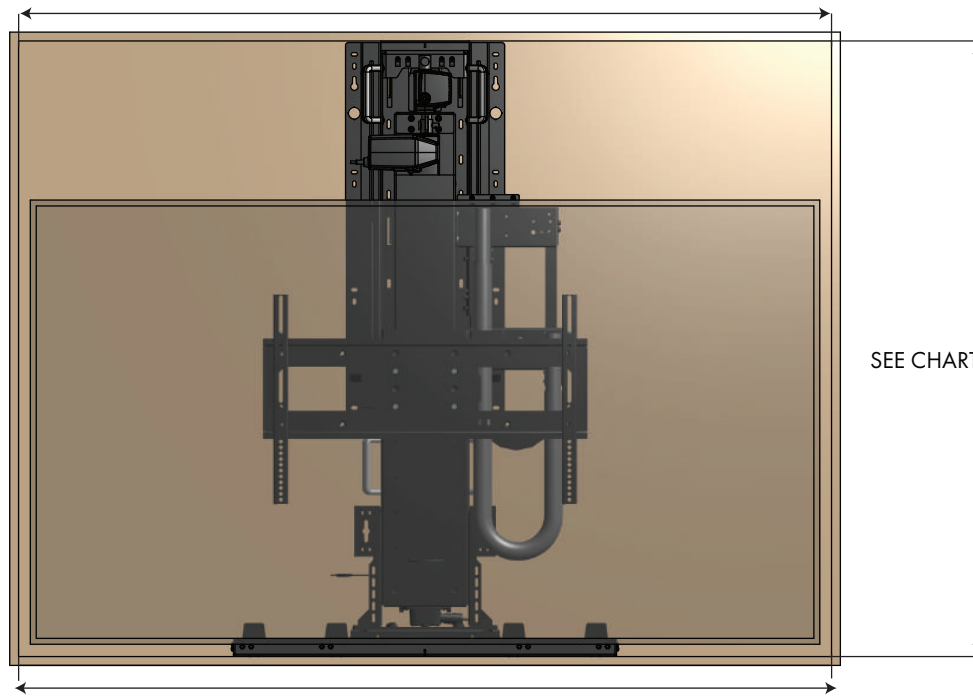

MIN. CEILING COVER CUTOUT WIDTH = TV WIDTH + 2 in [5.1 cm] OR 35 in [88.9 cm]
 WHICHEVER IS GREATER

MIN. INTERIOR ENCLOSURE DEPTH = TV DEPTH + 9.75 in [24.8 cm]

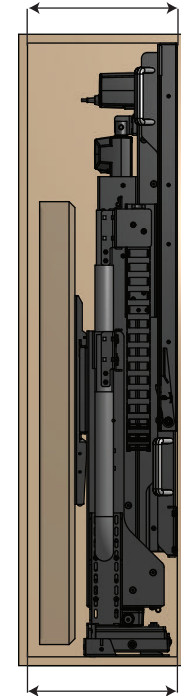

MIN. CEILING COVER CUTOUT DEPTH = TV DEPTH + 9.75 in [24.8 cm]

NOTES:

1. THE ENCLOSURE BOX SHOWN IN THE DIAGRAM IS FOR REFERENCE ONLY AND IS NOT PROVIDED WITH THE LIFT SYSTEM
2. WHEN DETERMINING TV HEIGHT, ALWAYS USE MANUFACTURER SUPPLIED "TV WITHOUT STAND" HEIGHT
3. LIFT MECHANISM IS POWDER COATED BLACK STEEL, COLORS IN DIAGRAM ARE FOR CLARITY ONLY
4. FOR REFERENCE DIMENSIONS, SEE PAGE 2 OF THIS DIAGRAM
5. DESIGNED FOR CEILING HEIGHT OF 8 TO 10 FEET [2.4 m to 3 m]
6. LIFT ENCLOSURE'S REAR PANEL SHOULD BE CONSTRUCTED TO WITHSTAND A LOAD OF 600 LBS [272.2 kg] OR MORE

NEXUS 21

COPYRIGHT 2023 - ALL RIGHTS RESERVED
 UPDATED 10/30/23

MODEL L-77ix DIAGRAM ENCLOSURE REFERENCE DIMENSIONS

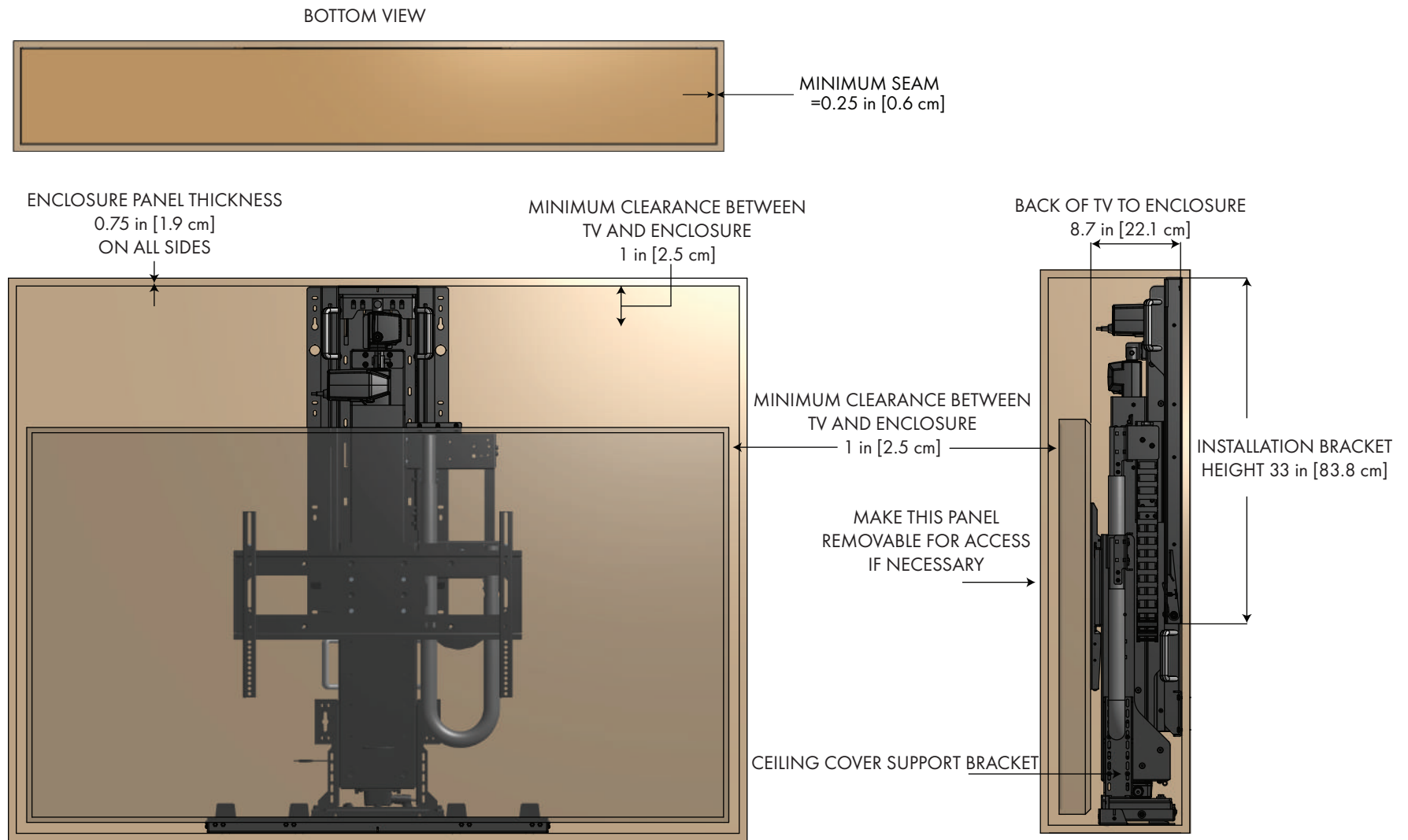

NOTES:

1. CEILING COVER SUPPORT BRACKETS ALLOW CEILING COVER TO SIT FLUSH WITH SURROUNDING CEILING MATERIAL
2. MAKE FRONT PANEL OF ENCLOSURE REMOVABLE FOR ACCESS IF NECESSARY

NEXUS²¹

COPYRIGHT 2023 - ALL RIGHTS RESERVED
UPDATED 10/30/23

MODEL L-77ix DIAGRAM LIFT IN MOTION

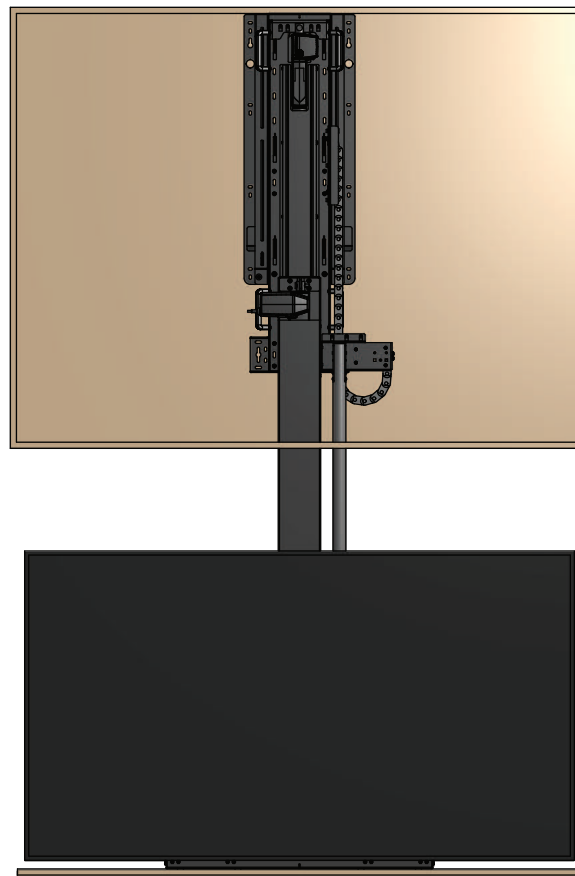
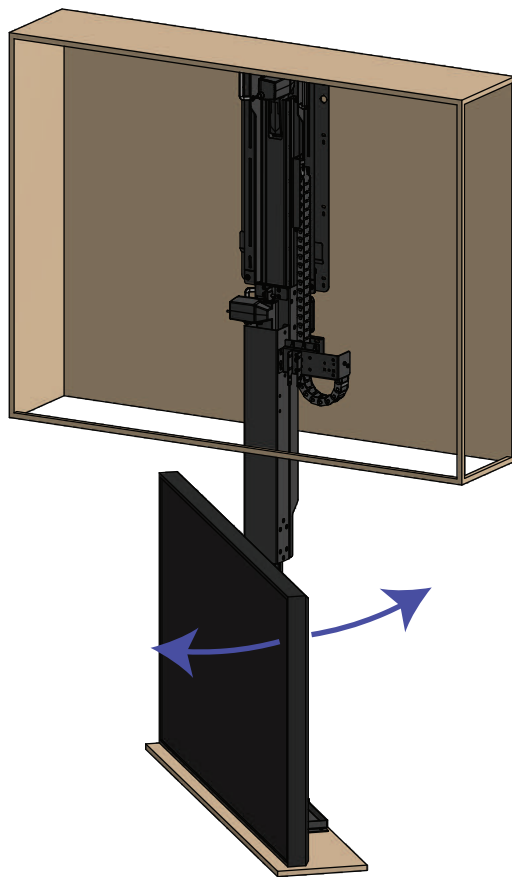

INTERIOR ENCLOSURE HEIGHT TABLE		
TV HEIGHT	MIN INTERIOR ENCLOSURE HEIGHT	MAX INTERIOR ENCLOSURE HEIGHT
39.5 in [100.3 cm] or less	52.25 in [132.7 cm]	57.75 in [146.7 cm]
40 in [101.6 cm]	52.75 in [134 cm]	
41 in [104.1 cm]	53.75 in [136.5 cm]	
42 in [106.7 cm]	54.75 in [139 cm]	
43 in [109.2 cm]	55.75 in [141.6 cm]	
44 in [111.8 cm]	56.75 in [144.1 cm]	
45 in [114.3 cm]	57.75 in [146.7 cm]	

*IF YOUR TV HEIGHT FALLS BETWEEN TWO INCREMENTS, EITHER ROUND UP TO THE NEXT ROW ON THE CHART, OR ADD THE AMOUNT IT IS OVER TO THE MINIMUM INTERIOR ENCLOSURE HEIGHT.

EXAMPLE: TV HEIGHT = 41.25 in...EITHER USE 54.75 FOR YOUR MIN INTERIOR ENCLOSURE HEIGHT OR ADD .25 in TO 53.75 AND USE 54 in FOR YOUR MIN INTERIOR ENCLOSURE HEIGHT

NOTES:

1. LIFT MUST BE ABLE TO TRAVEL TO FULL EXTENSION WITHOUT OBSTRUCTIONS, YOU CANNOT LIMIT THE STROKE OF THIS LIFT.
2. SWIVEL IS MOTORIZED ONLY, CANNOT BE MANUALLY TURNED.
3. SWIVEL MUST BE ABLE TO REACH 20° IN BOTH DIRECTIONS.
4. ENSURE LIFT IS CLEAR OF ALL OBSTRUCTIONS BEFORE SWIVELING.

NEXUS²¹

COPYRIGHT 2023 - ALL RIGHTS RESERVED
UPDATED 10/30/23

MODEL L-77ix DIAGRAM

CEILING COVER INFORMATION

IMPORTANT: THE L-77ix FEATURES A NEW CEILING COVER DESIGN - YOU MUST NOT CREATE A CEILING COVER CATCH AS PART OF YOUR INSTALLATION. THE CEILING COVER MUST BE ABLE TO RETRACT ABOVE IT'S NORMAL CLOSED POSITION AS A PART OF THE RESET PROCEDURE.

CREATING A CEILING COVER CATCH WILL CAUSE DAMAGE TO YOUR LIFT SYSTEM AND VOID THE 10-YEAR WARRANTY.

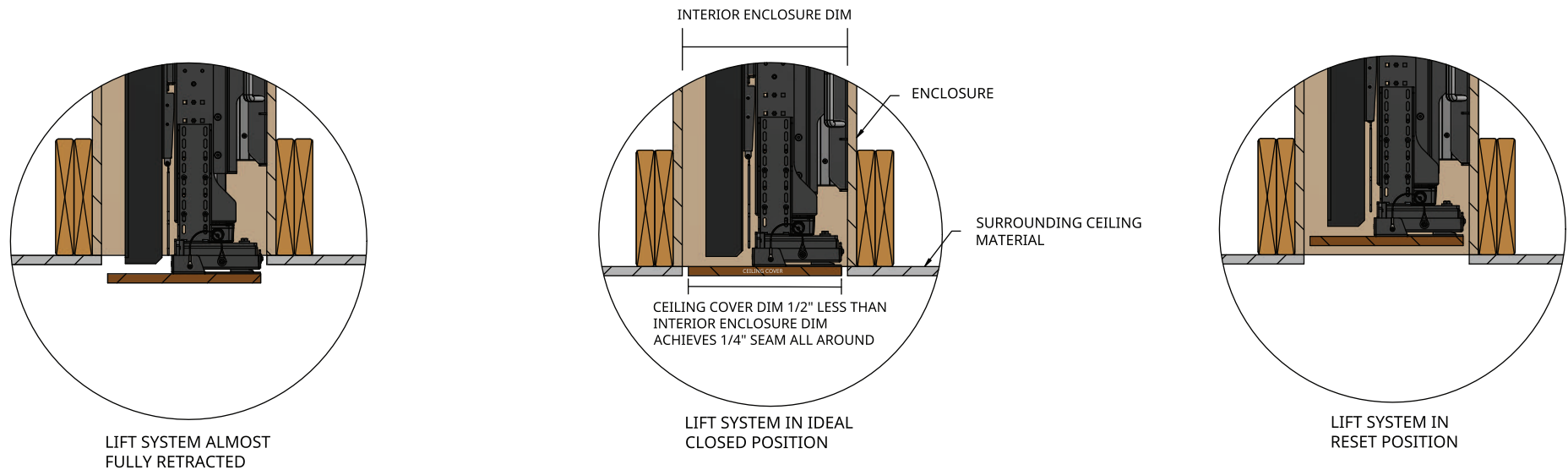

NOTES:

1. UNLIKE OTHER NEXUS 21 LIFT MODELS, YOU WILL NOT INSTALL A CEILING COVER CATCH FOR THIS LIFT.

NEXUS₂₁

COPYRIGHT 2023 - ALL RIGHTS RESERVED
UPDATED 10/30/23

SURFACE MOUNTING INFORMATION

SPECIFICATIONS

MINIMUM STRINGER HEIGHT : 33 in [83.8 cm]
MINIMUM STRINGER WIDTH: 17.5 in [44.5 cm]
ASSUMES MIN 16 in ON CENTER STUD SPACING. ADJUST AS NECESSARY FOR LARGER STUD SPACING
MINIMUM STRINGER THICKNESS: 3/4 in [1.9 cm]

CAUTION:

**DO NOT INSTALL
INTO DRYWALL ALONE**

**A STRINGER BOARD
MUST BE USED AND MUST
BE SECURED TO
A MINIMUM OF
2 STUDS.**

**HARDWARE TO SECURE
STRINGER BOARD TO
STUDS IS NOT PROVIDED
BY NEXUS 21.**

**DRYWALL ALONE WILL
NOT SUPPORT THE
WEIGHT OF
THE INSTALLATION.**

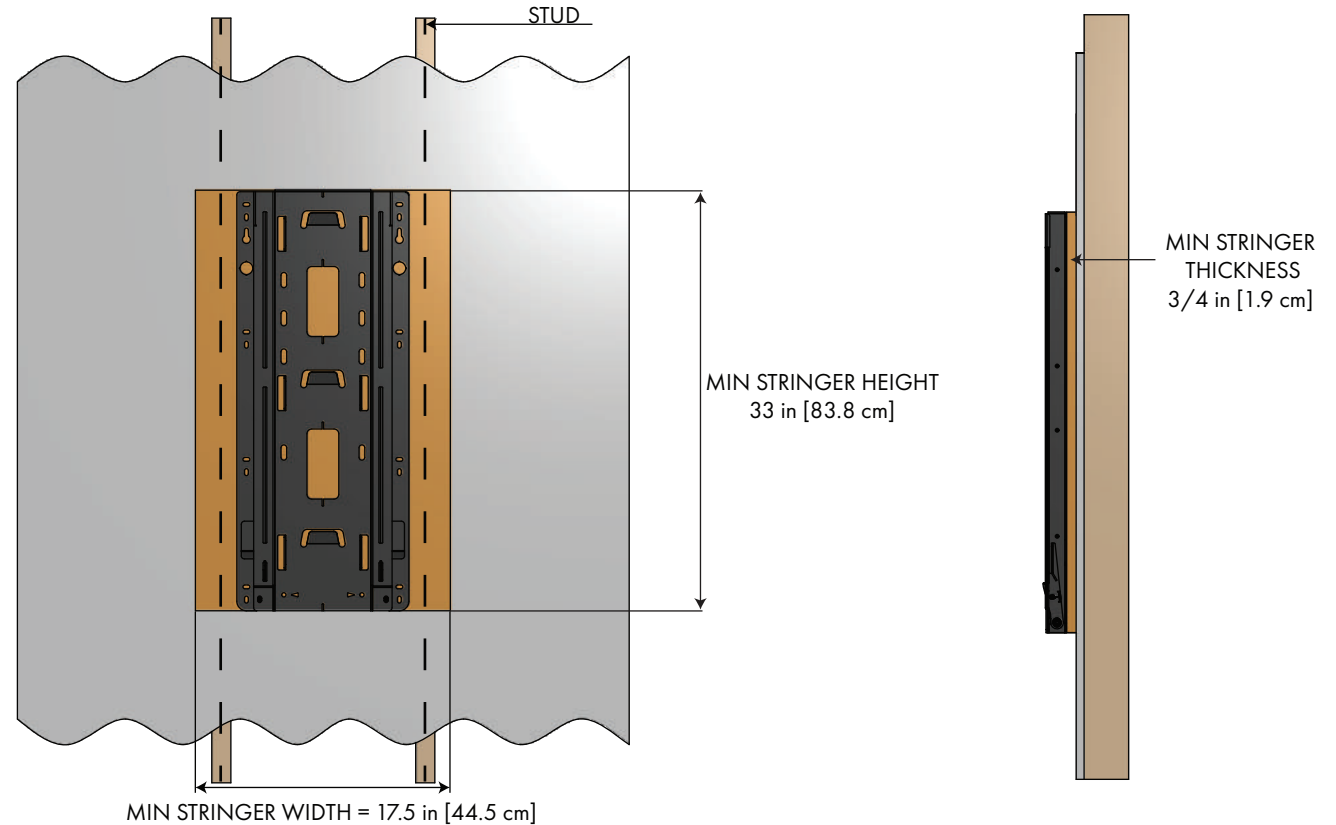

MIN STRINGER WIDTH = 17.5 in [44.5 cm]
ASSUMES MIN 16 in ON CENTER STUD SPACING. ADJUST AS NECESSARY FOR LARGER STUD SPACING

NOTES:

1. THE STRINGER BOARD SHOWN IN THE DIAGRAM IS FOR REFERENCE ONLY AND IS NOT PROVIDED WITH THE LIFT SYSTEM.
2. THE STRINGER BOARD AND WALL SHOULD BE CONSTRUCTED TO WITHSTAND A LOAD OF 600 LBS [272.2 kg] OR MORE.
3. STRINGER BOARD IS USED TO TRANSFER THE LOAD TO THE WOOD FRAME STUDS INSTEAD OF DRYWALL.
4. INSTALLATION BRACKET TO BE SECURED TO STRINGER BOARDS WITH (6) HEX HEAD BOLTS & (2) ANCHORS PROVIDED BY NEXUS 21

NEXUS 21

COPYRIGHT 2023 - ALL RIGHTS RESERVED
UPDATED 10/30/23

SURFACE MOUNTING INFORMATION

SPECIFICATIONS

MINIMUM STRINGER HEIGHT : SEE DETAILS BELOW

MINIMUM STRINGER WIDTH: 17.5 in [44.5 cm]

ASSUMES MIN 16 in ON CENTER STUD SPACING. ADJUST AS NECESSARY FOR LARGER STUD SPACING

MINIMUM STRINGER THICKNESS: 3/4 in [1.9 cm]

CAUTION:

**DO NOT INSTALL
INTO DRYWALL ALONE**

**TWO STRINGER BOARDS
MUST BE USED AND MUST
BE SECURED TO
A MINIMUM OF
2 STUDS EACH.**

**HARDWARE TO SECURE
STRINGER BOARDS TO
STUDS IS NOT PROVIDED
BY NEXUS 21.**

**DRYWALL ALONE WILL
NOT SUPPORT THE
WEIGHT OF
THE INSTALLATION.**

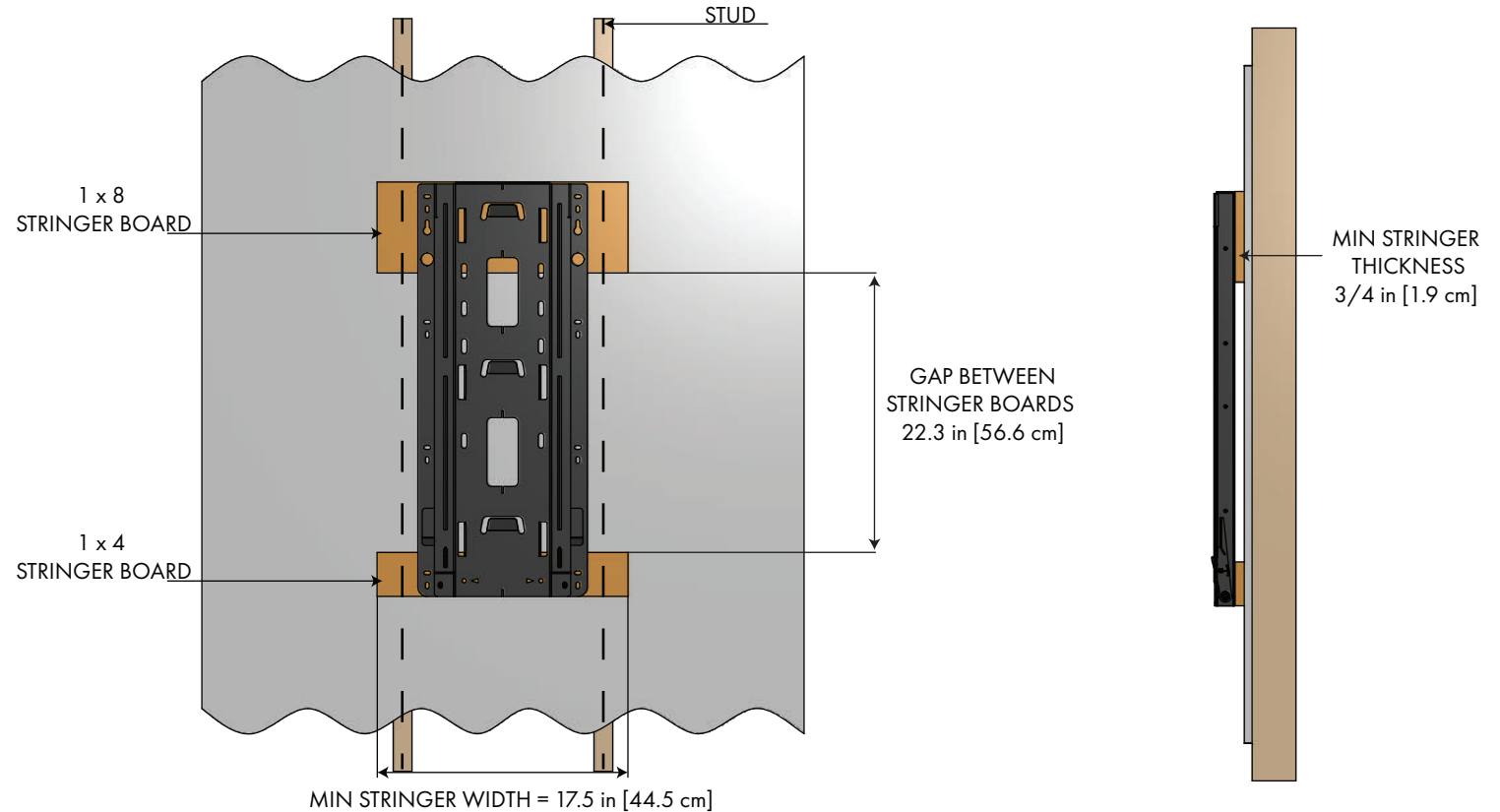

ASSUMES MIN 16 in ON CENTER STUD SPACING. ADJUST AS NECESSARY FOR LARGER STUD SPACING

NOTES:

1. THE STRINGER BOARDS SHOWN IN THE DIAGRAM ARE FOR REFERENCE ONLY AND IS NOT PROVIDED WITH THE LIFT SYSTEM.
2. THE STRINGER BOARDS AND WALL SHOULD BE CONSTRUCTED TO WITHSTAND A LOAD OF 600 LBS [272.2 kg] OR MORE.
3. STRINGER BOARDS ARE USED TO TRANSFER THE LOAD TO THE WOOD FRAME STUDS INSTEAD OF DRYWALL.
4. INSTALLATION BRACKET TO BE SECURED TO STRINGER BOARDS WITH (6) HEX HEAD BOLTS & (2) ANCHORS PROVIDED BY NEXUS 21

NEXUS 21

COPYRIGHT 2023 - ALL RIGHTS RESERVED
UPDATED 10/30/23